

ArchitEX™
Structural Profiles & Structures

Double Web Beam Product Guide

Global leaders in the supply of Engineer
Designed Fibreglass Reinforced Plastic (FRP)
Structural Profiles and Solutions

The Treadwell team is delighted to introduce the latest revision of our ArchitEX™ Double Web Beam Product Guide, showcasing the largest range of Fibreglass Reinforced Plastic (FRP) profiles in the market and the ultimate tool for designing FRP structures.

The data in this FRP Product Guide has been collated to ensure that engineers and architects have the ideal reference available to them while designing structures that incorporate FRP pultrusions.

While this guide offers a huge resource of information and statistics relevant to FRP structural profiles, it is impossible to embrace the flexibility and constant evolution of the ArchitEX™ FRP composite range in one publication. To ensure that you have the most up to date information on the ArchitEX™ range of profiles and applications or to simply draw on our team's experience in this unique industry, contact us via the relevant numbers or visit www.treadwellgroup.com.au.

This product guide is also available online, so if you are concerned that your copy may not be the latest, you can request an updated hardcopy or download it at www.treadwellgroup.com.au.

A BRIEF HISTORY

Treadwell Group is one of the most established names in the supply of Access Systems throughout Australia. Our centrally located Adelaide fabrication facility, coupled with our second to none distribution network across Australia, and our commitment to quality and testing, allows our technical staff to provide engineering and design assistance for any project.

With a broad history of installation in a wide range of challenging applications, including industrial process plants, mining applications, marine and coastal environments, as well as public infrastructure, Treadwell has the experience to help you specify the right resin systems and products every time.

If you have any unique design problems, chances are we've encountered something similar before. Get in contact today.



Treadwell Group Pty Ltd

Australia
P 1800 246 800
sales@treadwellgroup.com.au
treadwellgroup.com.au

New Zealand
P 0800 244 600
sales@treadwellgroup.co.nz
treadwellgroup.co.nz

TREADWELL™

Scope of Shapes

Easy integration to various parts due to the capability to essentially shape any item with a constant cross section which can be pultruded.

Composite Design Engineering

A standard shape customised into a pultrusion by modifying the resin or reinforcement to achieve a particular customer need.

Optimising Resins

Standard resins can be modified or special resins can be used to maximise performance of the pultrusion in challenging environments, such as those found in high temperature or extremely corrosive areas. Typical resins include polyesters, vinyl esters, PVC, epoxies, phenolics, urethanes and blends.

Choice of Reinforcements

The type, form, placement and quantity of reinforcements can be customised to optimise economy, develop ascribed strength and create or enhance other physical characteristics of a pultruded part. Typical reinforcements used include glass or carbon fibres in multifilament strands, mat (long fibres held together with a resinous binder) or stitched fabrics.

Core Materials Options

Treadwell provides a range of core material options with comprehensive experience in pultruding over various materials including foam, balsa, polyethylene and aluminium.

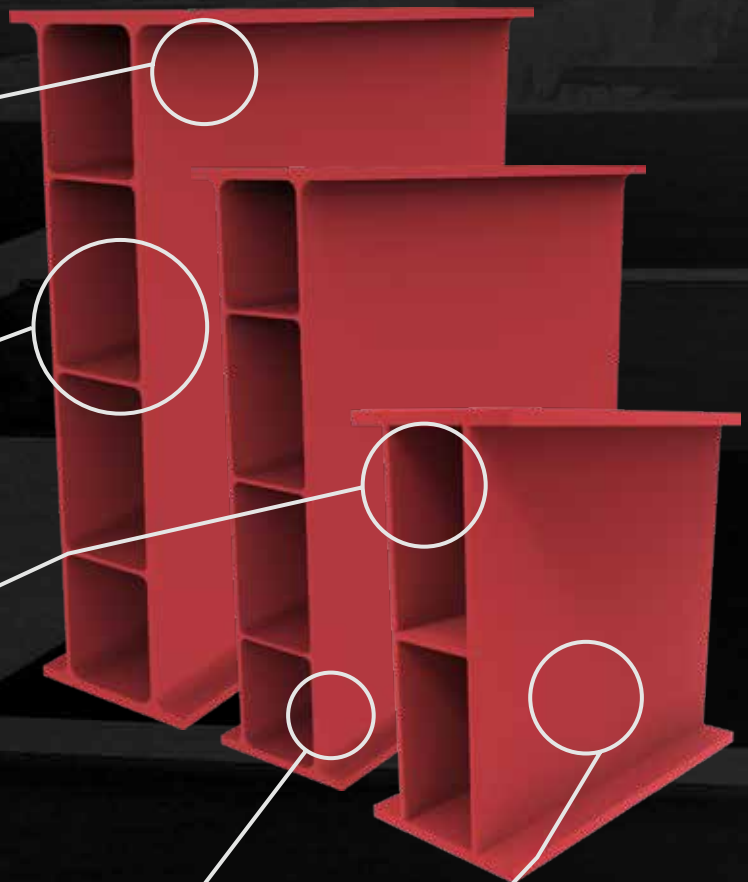

Oil and Gas

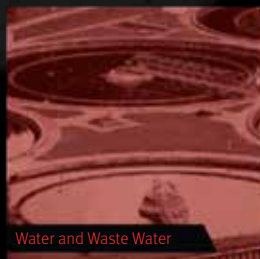

Water and Waste Water



Mining and Minerals



Aquaculture



Maritime & Shipping

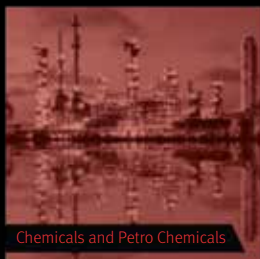

Chemicals and Petro Chemicals



Pulp and Paper



Food and Beverage



Section One: Introduction to Pultrusions

- 04 Composition of Pultrusions
- 05 Resin Systems
- 06 The Pultrusion Process
- 07 Environmental Conditions

Section Two: Coupon Properties

- 08 ArchitEX™ Profiles
- 09 Comparison

Section Three: General Tolerances

- 11 Cross Sectional Tolerance
- 12 Straightness
- 13 Twist

Section Four: Sectional Properties

- 15 Elements of Sections of Structural Shapes
- 16 Sectional Properties



Quality Policy

Quality is at the forefront of Treadwell Access Systems' working practices. With over 15 years of manufacturing to the highest quality standards, Treadwell Access Systems prides itself on its implementation of strict quality control measures, and strives to supply products that surpass customers' expectations. The company works on a policy of continuous improvement.



Environmental Policy

Treadwell Access Systems is conscious of the impact it has on the environment and its associated responsibilities. The company is committed to ensuring its operations satisfy both legal obligations and moral duties. Treadwell has been committed to sustainability for many years and is not just responding to current trends.

Introduction to Pultrusions

Composition of FRP Pultrusions

What are Pultrusions made of?

Pultrusions are composed of two key elements; glass fibre products and resin formulations. The glass contributes its inherent tensile flexural strength while the addition of resin ensures impact and corrosion resistance.

The glass fibre component normally consists of two different arrangements: glass roving which is unidirectional, and continuous mat which can be arranged in different ways to provide bi-directional stability as well as contributing to longitudinal strength properties.

Another integral part of a pultrusion is the surface veil which provides enhanced UV protection, corrosion resistance and aesthetics.

Roving

Roving is made up of fibreglass unidirectional filaments which are manufactured on continuous rolls. Roving is usually the principal element in a pultrusion, comprising 50% - 70% percent of the total glass content.

While supplying the necessary strength to pull the profile during manufacture, the roving also provides unsurpassed tensile and flexural properties. The percentage of roving in a pultrusion is the major variable in section stiffness.

Mat

Continuous strand mat constitutes the remainder of the glass reinforcement used in the pultrusion process. This would typically be 30% - 50% of the total glass content. It is important to differentiate between continuous strand mat and other hand-laid-up or press-moulded processes that utilise short chopped fibres. The mat that is used in the pultrusion process requires good tractive strength to ensure that it enters the die properly.

Fibreglass continuous strand mat is predominately applied to obtain the desired transverse properties of the product, whereas roving provides longitudinal stability to a section. Roving lacks the required lateral cohesion that is also an essential element in maintaining the maximum strength from a profile, it is the continuous strand mat that is principally responsible for this.

Surface Veil

Veils are utilised to enhance the surface properties of pultruded profiles. Most widely used today are synthetic variations which enhance the UV resistance properties and aesthetics. The veil also increases the resin content of the surface of the pultrusion which provides added corrosion resistance. The veil protects the section against moisture and therefore the mechanical characteristic values remain unchanged for sustained end-use conditions.

Cross Section of Pultrusion

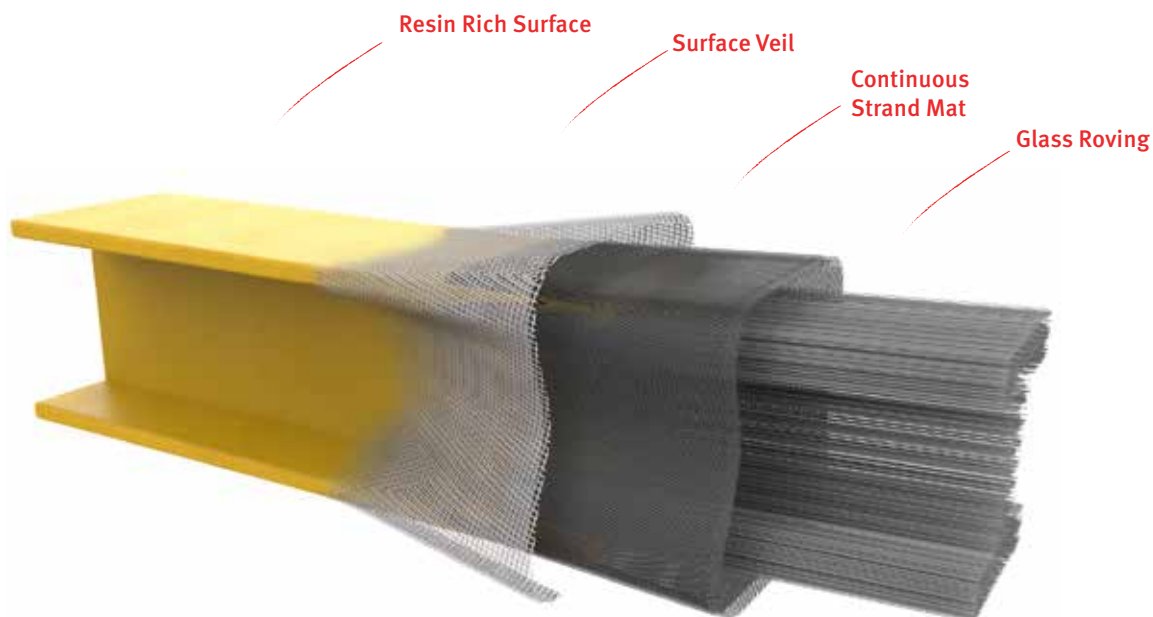

Resin Systems

When choosing a resin type for your application, we highly recommend you consult with us in relation to the application to ensure the correct resin is specified. Considerations such as corrosion, environment, temperature, fire resistance, smoke and smoke toxicity requirements must be taken into account, and will dictate which resin system should be utilised for optimum performance over time. Below is an overview of the resin systems offered in the ArchitEX™ range.

O-Series® is an architectural grade polyester resin system with an intermediate level of chemical resistance, and is a good choice for commercial or light industrial applications, especially in areas where moisture is prevalent. O-Series® is often utilised for public infrastructure applications where it has been proven to outperform traditional timber decking products. This system is available with or without fire retardant additives.

I-Series® is a premium isophthalic resin system. This system provides an intermediate level of chemical resistance and is the correct choice for areas subjected to splash and spill contact with harsh chemicals. This system is an excellent general purpose resin and is a more favourably priced alternative to the vinyl ester system. This system has a flame spread of 25 (approximately 15) or less.

V-Series® Vinyl ester resin is the most high quality chemical resistant system offered in the industry and has been developed for use in environments where FRP products are subject to frequent and direct contact with the harshest of chemical, including a broad range of acids and caustics. This system has a flame spread of 25 (approximately 15) or less.

P-Series® The phenolic resin system is a system designed specifically for use where fire resistance, low smoke and low toxic fumes are critical. P-Series® is typically used in offshore applications and confined spaces where such criteria are an absolute necessity. This system is tested in accordance with ASTM E-84. Various products also conforming to US Coast Guard Approvals, Level 2 and 3, are also offered by Treadwell. This particular resin system has a flame spread rating of 5 and a smoke density rating of 5.

Standards Resin Systems Comparison Chart

	Chemical Resistance	Fire Retardance	Low Smoke	Halogen Free	Temperature Performance
O-Series® Polyester	● ● ●	● ● ● ●	—	—	● ● ●
I-Series® Isophthalic	● ● ● ● ●	● ● ● ● ●	—	—	● ● ● ●
V-Series® Vinyl Ester	● ● ● ● ●	● ● ● ● ●	—	—	● ● ● ● ●
P-Series® Phenolic	● ● ● ●	● ● ● ● ●	● ● ● ●	● ● ● ● ●	● ● ● ● ●

ArchitEX™ Features and Benefits vs. Traditional Alternatives

	ArchitEX™	Stainless Steel	Galvanised Steel	Aluminium	Polyurethane
Chemical Resistance	● ● ● ● ●	● ● ● ●	●	● ● ●	● ● ● ●
Strength	● ● ● ● ●	● ● ● ● ●	● ● ● ● ●	● ● ● ● ●	● ● ●
Lightweight	● ● ● ● ●	●	●	● ● ● ● ●	● ● ●
Electrical Resistance	● ● ● ● ●	●	●	●	● ● ● ● ●
Cost Effectiveness	● ● ● ● ●	● ● ●	● ● ● ●	● ●	● ● ● ● ●

Introduction to Pultrusions

The Pultrusion Process

How the Pultrusion Machine Works

Pultruding is the process that is used to form continuous structural profiles out of fibreglass and resin composites. The process is performed by a pultrusion machine. The first pultrusion process was developed in the mid-1940s with further major development and greater recognition in the mid-1950s.

The term pultrusion was derived from a combination of the word pull and extrusion. There are some parallels between the two processes given that they both produce continuous profiles and involve some sort of forming die. The main difference being that the pultrusion process utilises a series of pullers, which draw the product through the entire process as compared to extruding, which uses pressure or a pushing force.

The pultrusion process commences with fibreglass roving being pulled off rolls, through a guide and then being combined with the continuous strand mat. It is this fibreglass component that provides the resistance to tension that is necessary in the pultrusion process. The raw fibre is pulled through a series of guides or rollers and then enters a resin impregnation bath. The resin is usually a thermo-setting resin.

Now that the fibres are thoroughly 'wetted out' with the resin, they pass through a series of tooling which arranges the fibres correctly and removes excesses of resin. This set of tooling and guides is referred to as the pre-former. At this stage, the surface veil is added.

The uncured composite is then pulled into a heated die which commonly consists of 2-3 differing stages of temperature which initiate the curing of the resin component. The profile that exits the die is now a cured pultruded fibreglass reinforced plastic composite.

It is this rigid profile that is gripped further down the line by the pulling mechanism which provides steady and continuous tractive effort. After passing through the pullers, the FRP profile reaches a cut-off saw. The saw cuts the pultrusion to the desired length without slowing or halting the process.

This way high strength and lightweight profiles can be created from fibreglass reinforced plastic to virtually any length required.

Pultrusion Machine

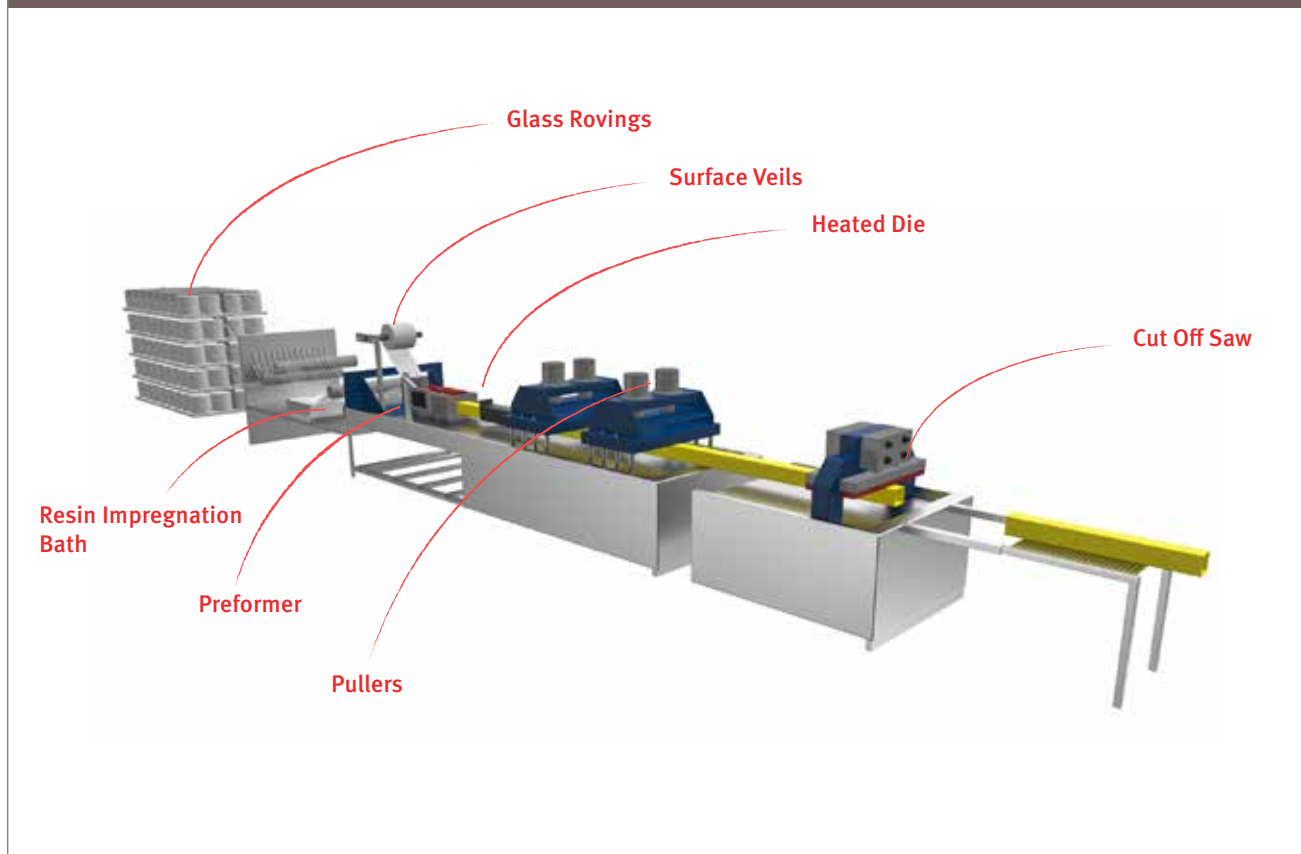

Environmental Conditions

Temperature

When designing a structure that is going to incorporate FRP sections, it is essential to consider environment changes such as temperature. Continued exposure to elevated temperatures can cause polyester and Vinyl Ester fibreglass pultrusions to lose certain percentages of their properties.

These tables shows the percentage of property retention when exposed to certain continuous temperatures.

Ultimate Stress

Temperature	Polyester	Vinyl Ester
37°C	85%	90%
51°C	70%	80%
65°C	50%	80%
79°C	Not Recommended	75%
93°C	Not Recommended	50%

Modulus of Elasticity

Temperature	Polyester	Vinyl Ester
37°C	100%	100%
51°C	90%	95%
65°C	85%	90%
79°C	Not Recommended	88%
93°C	Not Recommended	85%

Weathering

As with most plastic products, fibreglass reinforced pultrusions will undergo some form of visual degradation when exposed to outdoor weathering.

Typically, the surface of ArchitEX™ Pultrusions have good water and ambient temperature resistant properties but are susceptible to ultra-violet (UV) light. UV light is the light spectrum between 290 and 400 nanometres. This light has a higher energy and causes significant degradation to polymers by breaking chemical bonds or starting chemical reactions. The fire retardant polyester formulations contain a halogen which makes these plastics typically more susceptible to UV light degeneration.

Deterioration that has been caused by UV light can be identified by 'fade' and 'yellowing' on the pultrusion surface. Over an extended period of exposure, the actual glass fibres closest to the surface will become exposed. This state is known as fibrebloom and does not directly or immediately affect the physical properties of the section.

Treadwell adds a UV stabiliser into the resin formulation. This is especially important due to the extreme exposure that our products experience in the Pacific region. Also, to ensure that our pultruded products endure a protracted lifespan, we use high quality polyester surface veils to ensure that the structural component of the composite is protected as well as possible from damaging and corroding elements.

The ArchitEX™ range is also offered with a range of exterior coatings to enhance aesthetics. If a urethane coating is applied, this will also provide a hugely effective protection barrier to outdoor weathering.

Pultrusion Availability

Treadwell is arguably the largest stockist of FRP pultrusion products in Australia. We always stock a comprehensive range of I-Beam, C Section, Hollow Section and Angle products which are commonly in high demand. Due to the consistent and rapid evolution of the fibreglass pultrusion market, we are continually reevaluating our range of stocked products to ensure that our holdings accurately reflect customer demand.

We utilise efficient transport networks across Australia to ensure rapid delivery to remote locations and stock products in most capital cities.

Our complete range of products available is listed in the Section Properties tables. To obtain price and availability or find out if the product you require is a stock item, call Treadwell on 1800 246 800.





COMPARE		
	ArchitEX™	vs Steel
Corrosion Resistance	ArchitEX™ is available in either polyester or vinyl ester resin for resistance to a broad range of chemicals. Painting is beneficial in assisting with UV resistance when subjected to prolonged exposure.	Subject to oxidation and corrosion. Requires painting or galvanizing for many applications.
Weight	Lightweight - weight 25% as much as steel. 12.7mm thick plate = 22.95 kg/m ²	Could require lifting equipment to move and place. 12.7mm thick plate = 99.6 kg/m ²
Conductivity	Low electrical conductivity properties - high dielectric capability Low thermal conductivity 4 (BTU/SF/HR/F°/IN).	Conducts electricity. Potential Shock Hazard Thermal Conductivity 260-460 (BTU/SF/HR/F°/IN).
Strength	ArchitEX™ has a high strength-to-weight ratio and pound-for-pound is stronger than steel in the lengthwise direction. Tensile strength = 206.8MPa , CW = 48.2MPa	Homogeneous material. Tensile strength = 413.7MPa Yield strength = 248.2MPa
Stiffness	Modulus of Elasticity = 17.2GPa Will not permanently deform under working load.	Flexural modulus = 200MPa Modulus of Elasticity = 200GPa
Impact Resistance	Glass mats in ArchitEX™ distributes impact load to prevent surface damage. Will not permanently deform under impact.	Can permanently deform under impact.
EMI/RFI Transparency	Transparent to EMI/RFI transmissions.	Can interfere with EMI/RFI transmissions.
Versatility	Pigments added to the resin provide color throughout the part. Special colors available.	Must be painted for color. To maintain color and corrosion resistance, repainting may be required.
Easy Field Fabrication	ArchitEX™ can be field fabricated using simple carpenter tools with carbide or diamond tip blades. Lightweight for easier erection and installation.	Often requires welding and cutting torches. Heavier material requires special handling equipment to erect and install.
Cost	Lower installation and maintenance costs in industrial applications often equals lower lifecycle costs.	Lower initial cost.



General Tolerances

Cross Sectional Tolerances

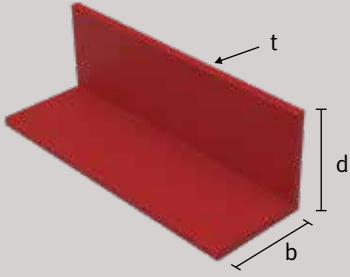
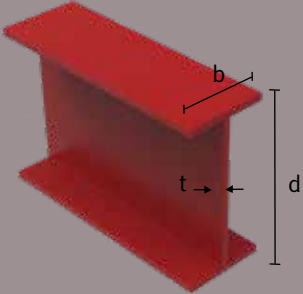
Shapes	Dimension	Tolerance % of Nominal	* Maximum or Minimum Tolerances
Angles 	t = thickness	± 10 %	± 0.26mm min.
	b = flange width	± 4 %	± 2.4mm max.
	d = depth	± 4 %	± 2.4mm max.
I, Wide Flange Section 	t = thickness	± 10 %	± 0.26mm min.
	b = flange width	± 4 %	± 2.4mm max.
	d = depth	± 4 %	± 2.4mm max.

General Tolerance

Cross Sectional Tolerance

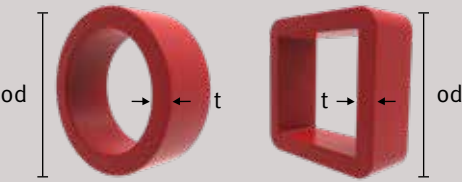
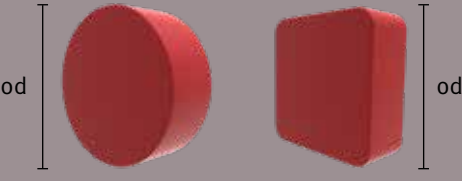
Shapes	Dimension	Outside Dimension Condition	Tolerances
Closed Shapes Round, Square and Rectangular Tubes 	t = thickness	All	0.25mm min
	od = outside dimension	All	2.39mm max
Round Rod & Square Bar 	od = outside dimension	All	2.39mm max

Flatness

Flatness is measured in the center with the weight of the profile minimising the deviation by contact with a flat surface

Structural Shapes Rods & Bars 	Allowable deviation from flat	
	Width	All Thickness
	Up to 25.4mm	0.2mm
Over 25.4mm	6.3mm	

Hollow Shapes 	Allowable deviation from flat		
	Width	Thickness under 4.8mm	Thickness 4.8mm and over
	Up to 25.4mm	0.3mm	0.2mm
Over 25.4mm	0.3mm x width	4.8mm x width	

Straightness

Straightness is measured in the centre with the weight of the pultrusion minimising the deviation by contact with a flat surface.

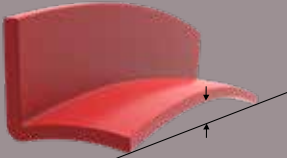
Angle, Beam and C Section 	Allowable deviation from straight	
	All widths	0.5 mm/m

Twist

Twist is measured with the weight of the pultrusion minimising the twist.

	Allowable twist
<p>Bars and other Structural Profiles other than Tubes</p> 	0.003°/mm
<p>Closed Profiles (Tubes)</p> 	0.003°/mm

Angularity

Angularity is the angle measured between two perpendicular faces of the profile.

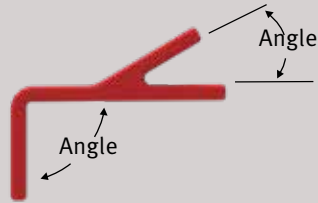
All Profiles	Allowable deviation from specific angle	
		Thickness up to 19mm

Cut Lengths

All Profiles	Allowable deviation from specific length	
	up to 2.44m	0 + 6.35mm
	2.44m <= 7.32m	0 + 12.7mm
	> 7.32m	0 + 76.2mm

*All parts being cut from stock must allow for blade width

Squareness of Endcut

All Profiles	Allowable deviation from specific length	
	Profiles over 50.8mm	± 1°

Sectional Properties

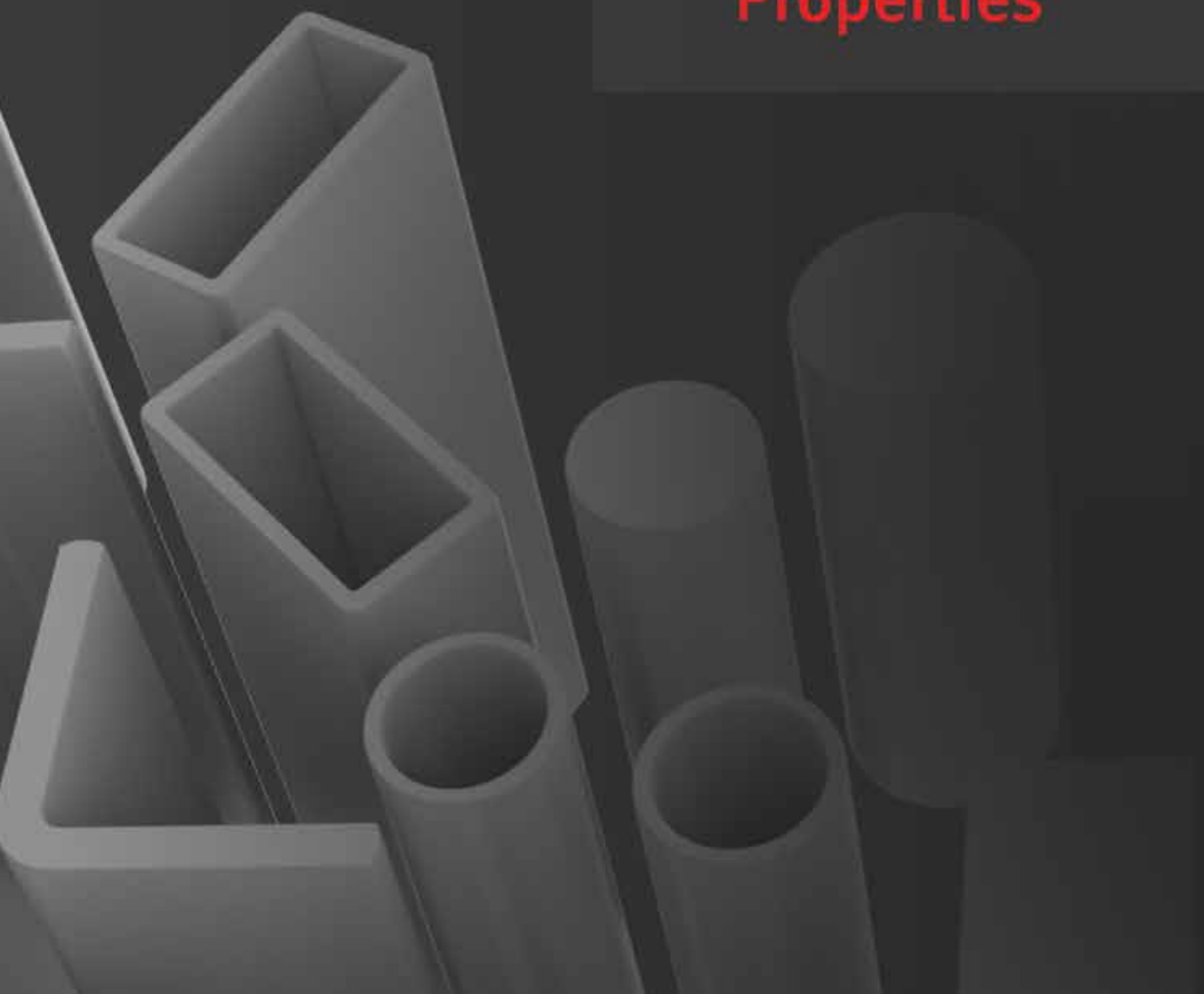

Elements of Sections of Structural Shapes

The section table values on the following pages have been calculated from nominal dimensions. All shapes shown in the tables are available, but not all are stocked. A shape availability list is included in the manual and, for convenience, availability information is noted on the individual uniform load tables.

Notation	
A	cross sectional area (mm. ²)
A _w	area of web (mm. ²)
b	width of section (mm.)
d	depth of section / diameter of rod (mm.)
h	depth between flanges (mm.)
I	moment of inertia (mm. ⁴)
J	torsion constant (mm. ⁴)
od	outside diameter of tube (mm.)
r	radius of gyration mm.)
S	section modulus (mm. ³)
t	thickness (mm.)
t _b	thickness of width dimension (mm.)
t _f	thickness of flange (mm.)
t _d	thickness of depth dimension (mm.)
t _w	thickness of web (mm.)
Wt.	weight of section (kg./m.)
C _x	x coordinate of centroid (mm.)
C _y	y coordinate of centroid (mm.)

Sectional Properties

Sectional Properties - Double Web Section

The section values shown on this page have been calculated from the nominal dimensions of the profile. All the shapes listed in the table are available but not all are stocked. For information on availability and price, contact Treadwell Group on 1800 246 800.

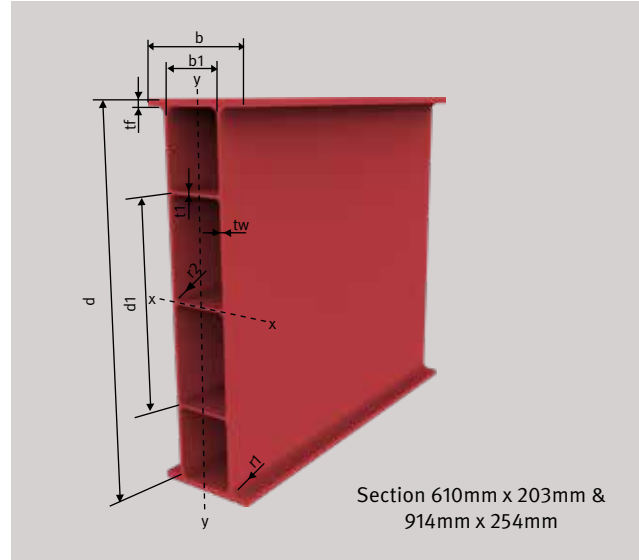
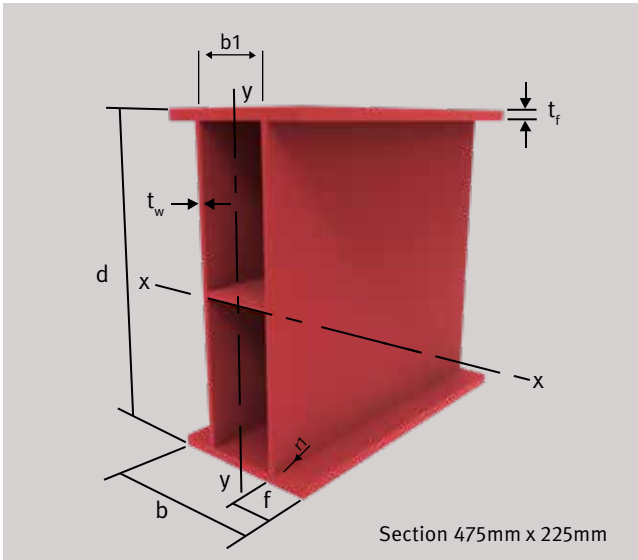

Double Web Section		Section Dimensions								
Part	Part Number	d mm	d ₁ mm	b mm	b ₁ mm	t _w mm	t _f mm	t ₁ mm	r ₁ mm	r ₂ mm
		Web		Flange						
475mm x 225mm	ARX-DW475221016	475	/	225	115	10	16	10	5	5
610mm x 203mm	ARX-DW6102030818	609.6	355.6	203.2	101.6	8	18	6	19.1	12.7
914mm x 254mm	ARX-DW9142540916	914.4	508	254	152.4	8.5	16	6.4	19.1	12.7

Double Web Section		Section Properties									
Part	Part Number	x-x				y-y				Area mm ²	Weight kg/m
		I mm ⁴	S mm ³	r mm	A _w mm ²	I mm ⁴	S mm ³	r mm	A _f mm ²		
475mm x 225mm	ARX-DW475221016	5.24 x 10 ⁸	2.21 x 10 ⁶	180.6	8900	6.07x10 ⁷	5.40 x 10 ⁵	61.5	7200	16060	28.9
610mm x 203mm	ARX-DW6102030818	9.86 x 10 ⁸	3.23 x 10 ⁶	226.5	9178	5.26 x 10 ⁷	5.18 x 10 ⁵	52.3	7315	19216	35.6
914mm x 254mm	ARX-DW9142540916	2.87 x 10 ⁹	3.26 x 10 ⁷	326.5	15001	1.41 x 10 ⁸	1.11 x 10 ⁶	72.5	8128	26908	49.7

Part: 475 X 225 x 10 x 16mm							
Part Number: ARX-DW4752251016							
			A_w	8900mm ²	Wt.	28.9kg/m	
			I	524000000mm ⁴	S	2210000mm ³	
Span (m)	Maximum Load (N/m)		Deflection (N/m)				
			L/100	L/150	L/180	L/240	L/360
4.27	50659	----	----	----	----	21276	----
4.57	46085	----	----	----	----	17689	----
4.88	41934	----	----	----	----	14768	----
5.18	38393	----	----	----	18772	12514	----
5.49	35155	----	----	21272	15954	10636	----
5.79	32374	----	----	21973	18310	13733	9155
6.10	29812	----	----	18953	15794	11846	7897
6.40	27597	----	----	16530	13775	10331	6888
6.71	25546	----	----	14437	12031	9023	6016
7.01	23760	----	19099	12733	10611	7958	5303
7.32	20638	----	15010	10007	8339	6254	4169
7.62	19315	----	13420	8947	7456	5592	3728
7.92	18072	----	12003	8002	6668	5001	3334
8.23	16976	----	10814	7209	6008	4506	3004
8.53	15941	----	9744	6496	5413	4060	2707
8.84	15024	----	8838	5892	4910	3683	2455
9.14	14155	----	8016	5344	4453	3340	2227
9.45	13382	----	7313	4876	4063	3047	2032
9.75	12645	----	6671	4447	3706	2780	1853
10.06	11987	----	6119	4079	3399	2550	1700
10.36	11359	----	5610	3740	3117	2338	1558
The part weight has been deducted in the above table.							

Safe Load & Deflection Tables

Part: 610mm X 203mm								
Part Number: ARX-DW6102030818								
		A_w	9177.6mm ²	Wt	35.6 kg/m			
		I	985921204mm ⁴	S	3234649.619mm ³			
Span (m)	Maximum Load (kN/m)	Deflection (kN/m)						
		L/150	L/200	L/250	L/300	L/350	L/400	
5	64.1	57.1	42.8	34.2	28.5	24.5	21.4	
6	44.5	35.0	26.3	21.0	17.5	15.0	13.1	
7	32.7	22.9	17.2	13.7	11.5	9.8	8.6	
8	25.1	15.7	11.8	9.4	7.9	6.7	5.9	
9	19.8	11.2	8.4	6.7	5.6	4.8	4.2	
10	16.0	8.3	6.2	5.0	4.2	3.6	3.1	
11	13.3	6.3	4.7	3.8	3.1	2.7	2.4	
12	11.1	4.9	3.7	2.9	2.4	2.1	1.8	
13	9.5	3.9	2.9	2.3	1.9	1.7	1.4	
14	8.2	3.1	2.3	1.9	1.6	1.3	1.2	
15	7.1	2.5	1.9	1.5	1.3	1.1	1.0	
16	6.3	2.1	1.6	1.3	1.0	0.9	0.8	
17	5.5	1.8	1.3	1.1	0.9	0.8	0.7	
18	4.9	1.5	1.1	0.9	0.7	0.6	0.6	
19	4.4	1.3	0.9	0.8	0.6	0.5	0.5	
20	4.0	1.1	0.8	0.6	0.5	0.5	0.4	
The part weight has been deducted in the above table.								

Safe Load & Deflection Tables

Part: 914mm X 254mm							
Part Number: ARX-DW9142540916							
		A_w	15000.8mm ²	Wt	49.7 kg/m		
		I	2868340400 mm ⁴	S	6273710.411mm ³		
Span (m)	Maximum Load (kN/m)	Deflection (kN/m)					
		L/150	L/200	L/250	L/300	L/350	L/400
5	123.6	144.8	108.6	86.9	72.4	62.1	54.3
6	86.5	92.0	69.0	55.2	46.0	39.4	34.5
7	63.6	61.6	46.2	37.0	30.8	26.4	23.1
8	48.7	43.0	32.3	25.8	21.5	18.4	16.1
9	38.5	31.1	23.3	18.7	15.6	13.3	11.7
10	31.1	23.2	17.4	13.9	11.6	9.9	8.7
11	25.7	17.7	13.3	10.6	8.9	7.6	6.6
12	21.6	13.8	10.4	8.3	6.9	5.9	5.2
13	18.4	11.0	8.2	6.6	5.5	4.7	4.1
14	15.9	8.9	6.6	5.3	4.4	3.8	3.3
15	13.8	7.2	5.4	4.3	3.6	3.1	2.7
16	12.2	6.0	4.5	3.6	3.0	2.6	2.3
17	10.8	5.0	3.8	3.0	2.5	2.2	1.9
18	9.6	4.2	3.2	2.5	2.1	1.8	1.6
19	8.6	3.6	2.7	2.2	1.8	1.6	1.4
20	7.8	3.1	2.3	1.9	1.6	1.3	1.2
The part weight has been deducted in the above table.							

Notes

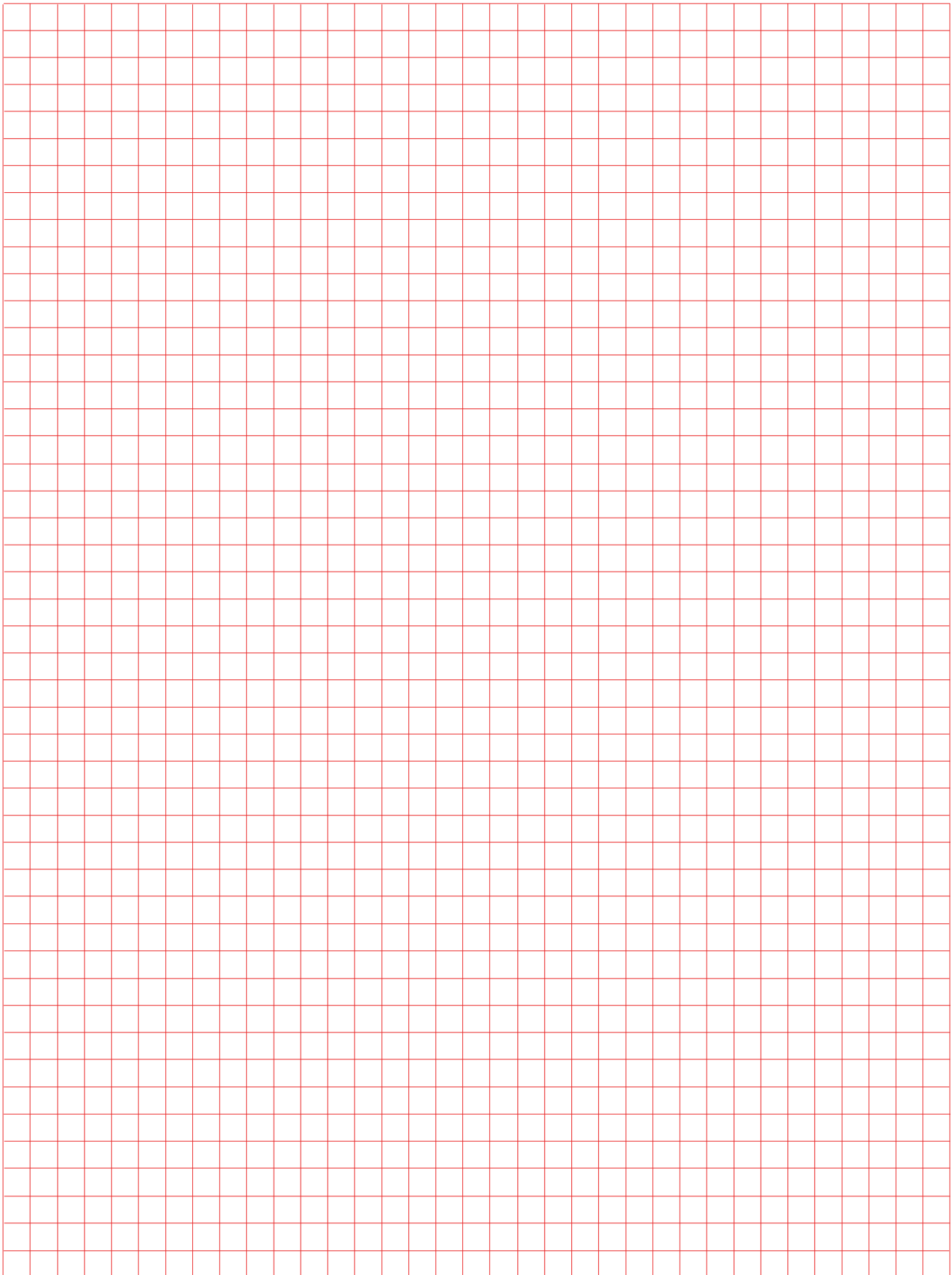



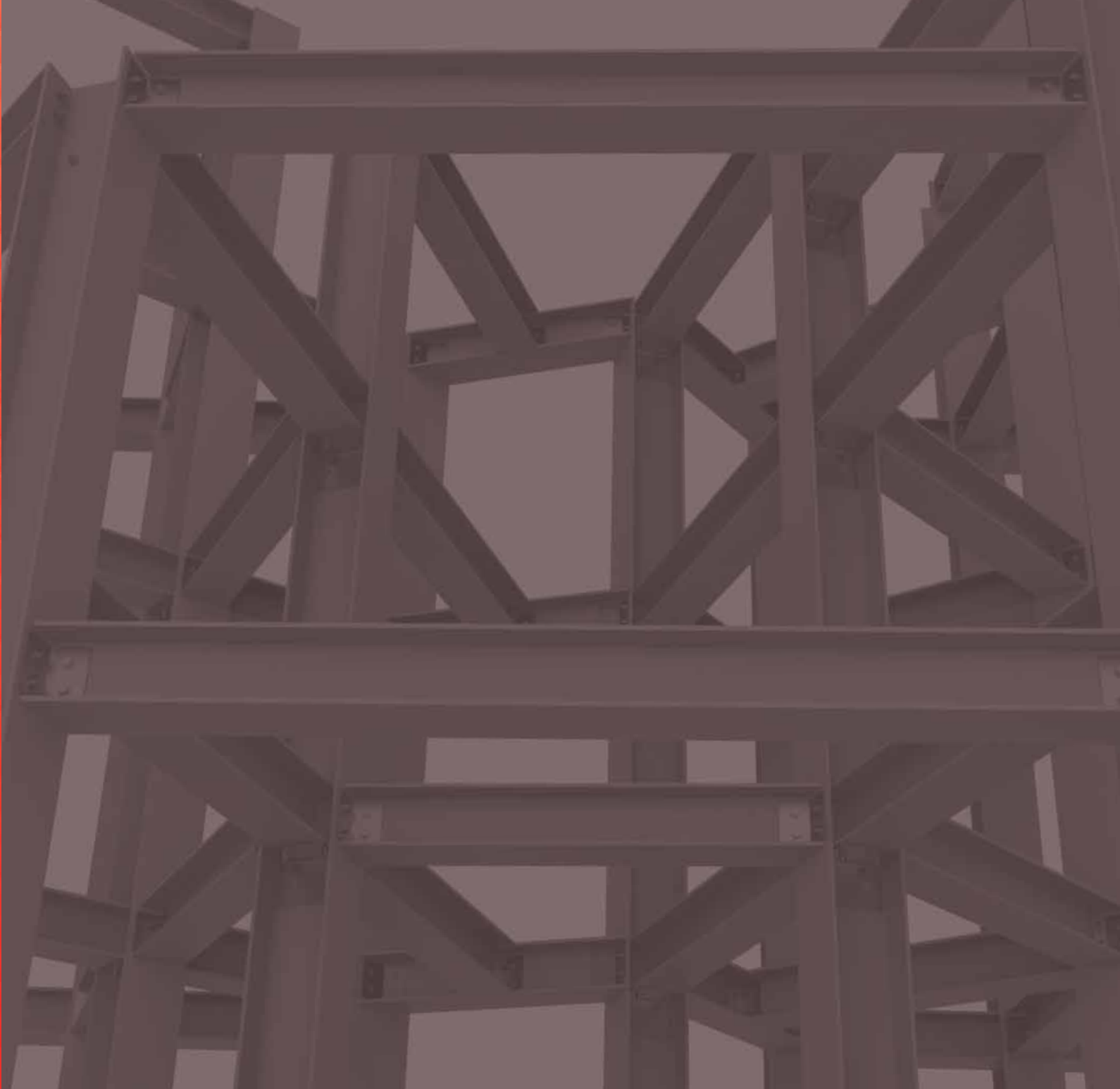
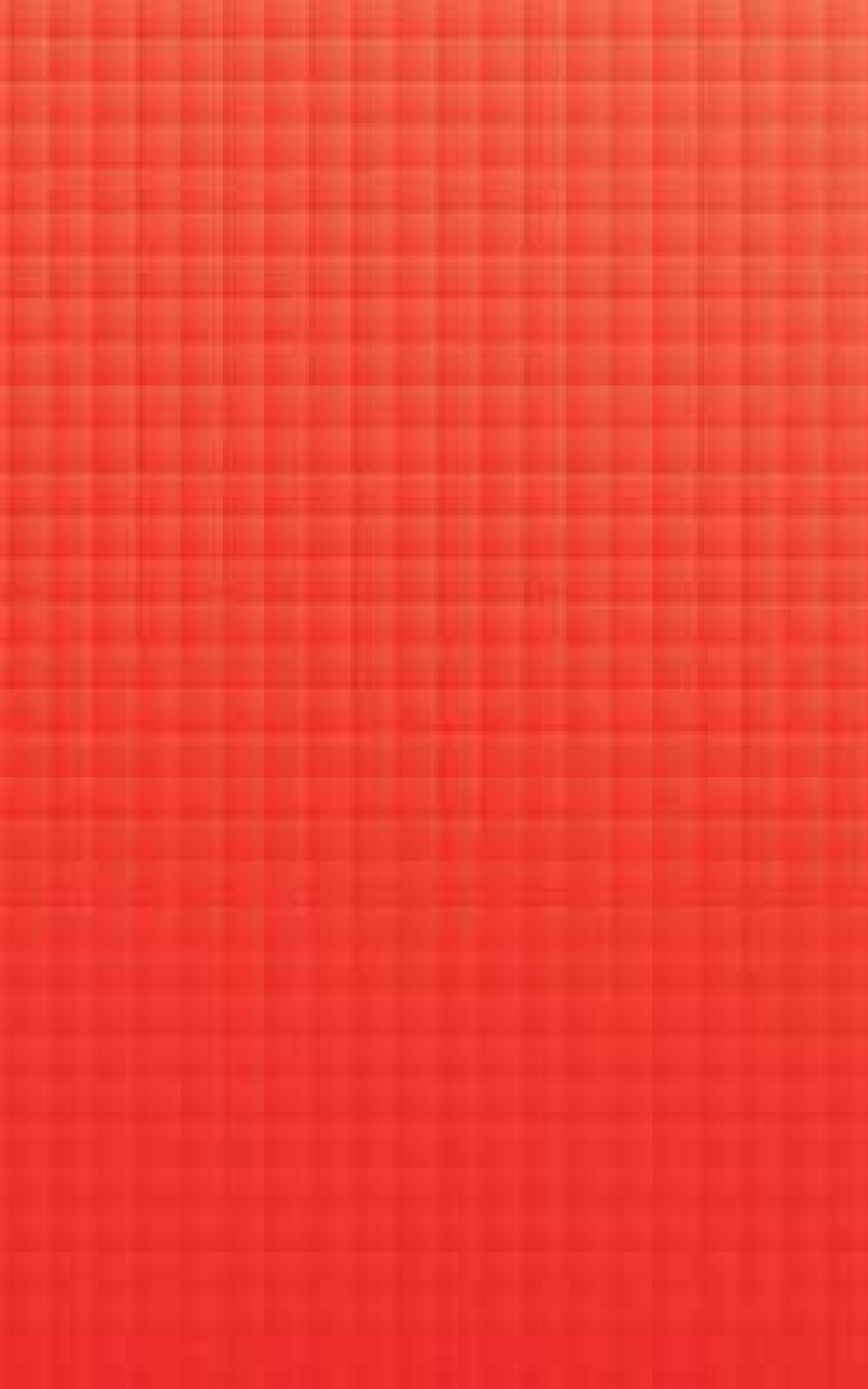

TREADWELL

Treadwell brands mentioned in this document are all registered brands of Treadwell Group Pty Ltd. All pictures and information are supplied as a guide only. The complete range of Treadwell products are developed, refined, made to meet and exceed stringent specifications for the worldwide market.

Important Note: Sales of products are subject to our Terms and Conditions which are available upon request. All specifications and photos are a guide only and are subject to change without notice. Please ring to confirm details. Treadwell products stated only comply with relevant standards mentioned within this publication when installed and used as they are designed to be.

